

- DE Gebrauchsanleitung
- FR Mode d'emploi
- NL Gebruikershandleiding
- GB User guide
- ES Guía del usuario
- IT Manuale di istruzioni
- SE Bruksanvisning
- CZ Uživatelská příručka
- DK Brugervejledning
- FI Käyttöohjeet
- GR Οδηγός χρήστη
- NO Brukeveiledning
- PL Instrukcja obsługi

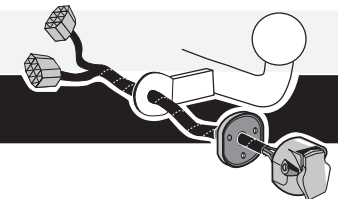

Partnr.: NI-032-DH

Gebrauchsanleitung (DE)	(CZ) Uživatelská příručka
Mode d'emploi (FR)	(DK) Brugervejledning
Gebruikershandleiding (NL)	(FI) Käyttöohjeet
User guide (GB)	(GR) Οδηγός χρήστη
Guía del usuario (ES)	(NO) Brukeveiledning
Manuale di istruzioni (IT)	(PL) Instrukcja obsługi
Bruksanvisning (SE)	



Nissan Note 2006-

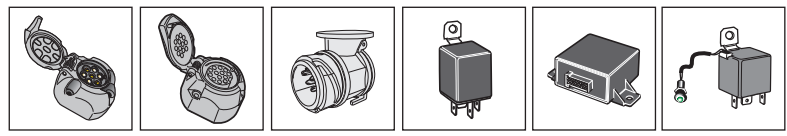

SPARE PARTS

www.ecs-electronics.com

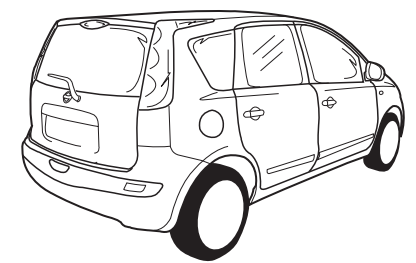
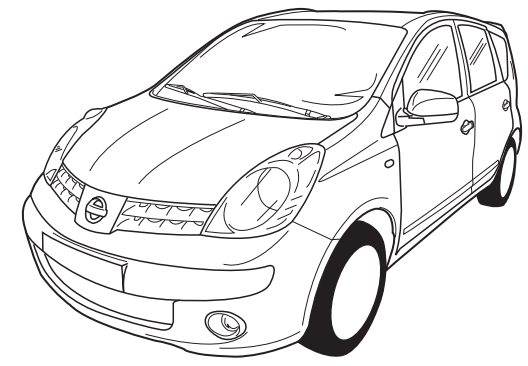

DE Anschluss Steckdose
FR Connection de la prise
NL Contactdoos aansluiting
GB Socket connection

ES Conexión de la caja de enchufe
IT Allaccio zoccolo
SE Anslutning kontaktdosa

CZ Objímkový konektor
DK Stikdåse forbindelse
FI Pistorasias liittämä

GR Υποδοχή σύνδεσης
NO Tillkobling koblingsboks
PL Połączenie przez gniazdo

DIN/ISO 11446	↩	1-8	↩	5/58-R 52W	6/54	7/58-L 52W	8	9	10	11	12	↩ 9
Pmax	1/L 21W	4/R 21W	Grün	52W	3x21W	52W	2x21W	180W/15Amp 180W/15Amp	10	11	12	13
DE	1/L Gelb	4/R Grün	Grün	Braun	Rot (1,00mm ²)	Schwarz/ Rot	Schwarz/ Rot	Braun/ Weiß (2,50mm ²)	Rot (2,50mm ²)	Weiß	Rot/ Blau	Weiß
FR	Jaune	Vert	Vert	Marron	Rouge (1,00mm ²)	Noir/ Rouge	Noir/ Rouge	Marron/ Blanc (2,50mm ²)	Rouge (2,50mm ²)	Blanc	Rouge/ Bleu	Blanc
NL	Geel	Groen	Groen	Bruin	Rood (1,00mm ²)	Zwart	Zwart/ Rood	Bruin/ Wit (2,50mm ²)	Rood (2,50mm ²)	Wit	Rood/ Blauw	Wit
GB	Yellow	Green	Green	Brown	Red (1,00mm ²)	Black Red	Black/ Red	Brown/ White (2,50mm ²)	Red (2,50mm ²)	White	Red/ Blue	White
ES	Amarillo	Verde	Verde	Marrón	Rojo (1,00mm ²)	Negro Rojo	Negro/ Rojo	Marrón/ Blanco (2,50mm ²)	Rojo (2,50mm ²)	Blanco	Rojo/ Azul	Blanco
IT	Giallo	Verde	Verde	Marrone	Rosso (1,00mm ²)	Nero Rosso	Nero/ Rosso	Marrone/ Bianco (2,50mm ²)	Rosso (2,50mm ²)	Bianco	Rosso/ Blu	Bianco
SE	Gul	Grön	Grön	Brun	Röd (1,00mm ²)	Svart Röd	Svart/ Röd	Brun/ Vit (2,50mm ²)	Röd (2,50mm ²)	Vit	Röd/ Blå	Vit
CZ	Žlutá	Zelená	Zelená	Hnědá	Červená (1,00mm ²)	Černá Červená	Černo/ Červená	Hnědo/ Bílá (2,50mm ²)	Červená (2,50mm ²)	Bílá	Červený/ Modrá	Bílá
DK	Gul	Grøn	Grøn	Brun	Rød (1,00mm ²)	Sort Rød	Sort/ Rød	Brun/ Hvid (2,50mm ²)	Rød (2,50mm ²)	Hvid	Rød/ Blå	Hvid
FI	Keltainen	Vihreä	Vihreä	Ruskea	Punainen (1,00mm ²)	Musta Punainen	Musta/ Punainen	Ruskea/ Valkoinen (2,50mm ²)	Punainen (2,50mm ²)	Valkoinen	Punainen/ Sininen	Valkoinen
GR	Κίτρινο	Πράσινο	Πράσινο	Καφέ	Κόκκινο (1,00mm ²)	Μαύο Κόκκινο	Μαύο/ Κόκκινο	Καφέ/ Λευκό (2,50mm ²)	Κόκκινο (2,50mm ²)	Λευκό	Κόκκινο/ Μπλε	Λευκό
NO	Gul	Grønn	Grønn	Brun	Rød (1,00mm ²)	Svart Rød	Svart/ Rød	Brun/ Hvit (2,50mm ²)	Rød (2,50mm ²)	Hvit	Rød/ Blå	Hvit
PL	Żółty	Zielony	Zielony	Brazowy	Czerwony (1,00mm ²)	Czarny Czerwony	Czarny/ Czerwony	Brazowy/ Biały (2,50mm ²)	Czerwony (2,50mm ²)	Biały	Czerwony/ Niebieski	Biały

DE Sicherungen austauschen
FR Remplacer les fusibles
NL Zekeringen vervangen
GB Changing the fuse
ES Cambio de fusible
IT Sostituire i fusibili
SE Byte av säkringar
CZ Výměna pojistky
DK Udskiftning af sikringer
FI Vaihtaa varokkeet
GR Αλλαγή ασφάλειας
NO Skifte sikringene
PL Wymienić bezpieczniki

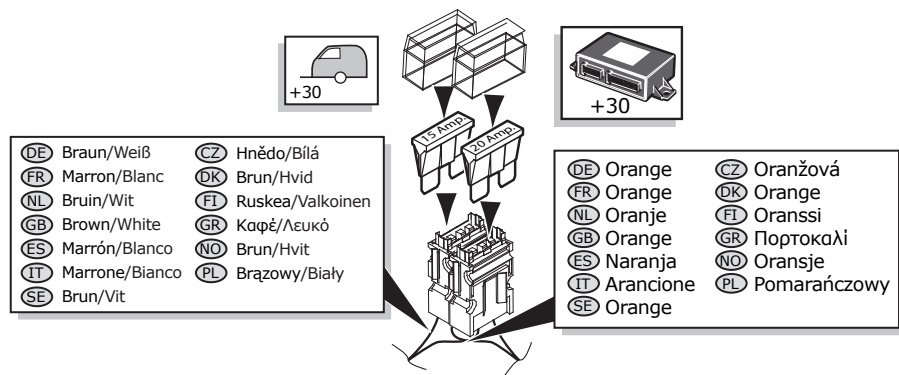
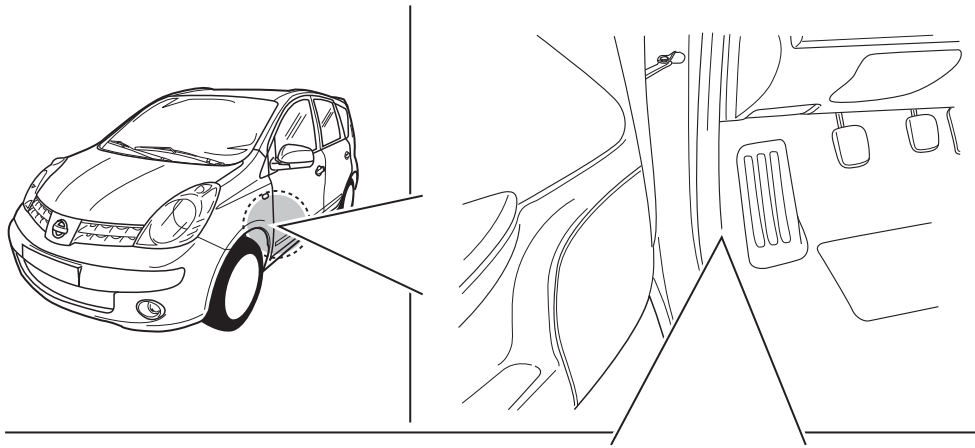

INFO : Storage

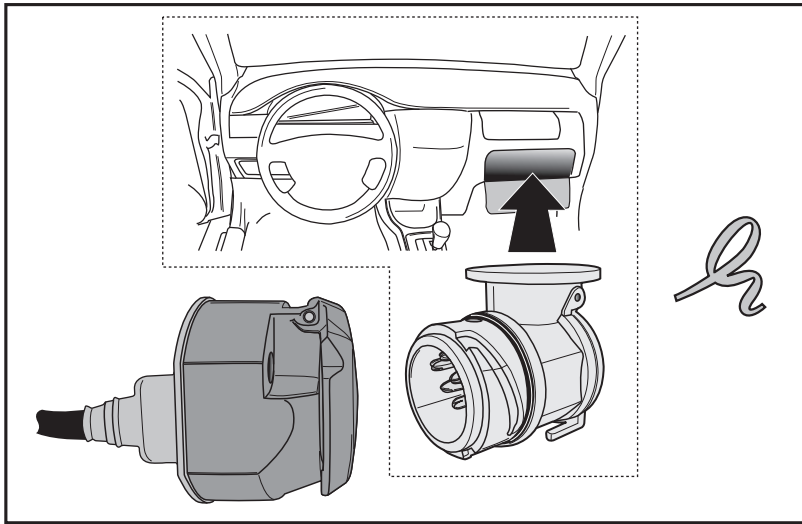
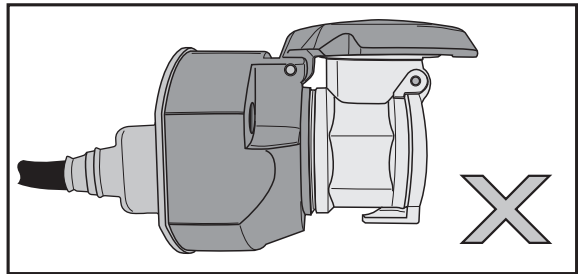
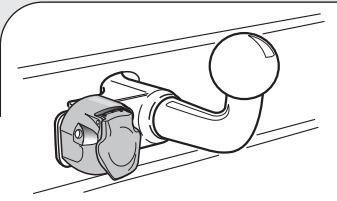
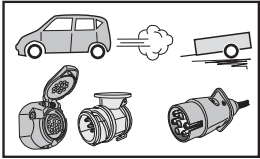

INFO

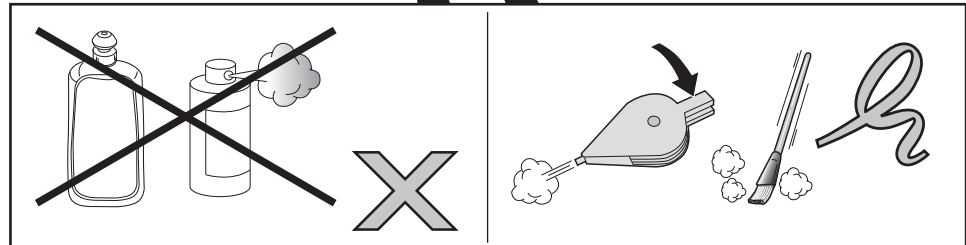
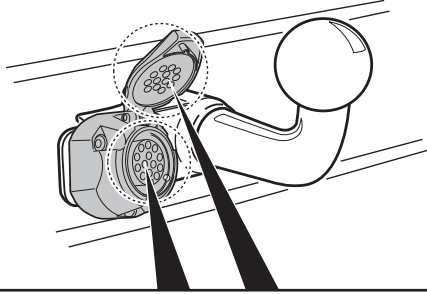
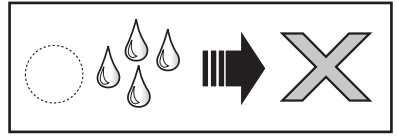
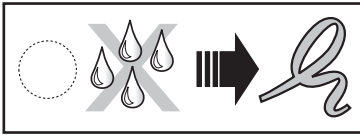
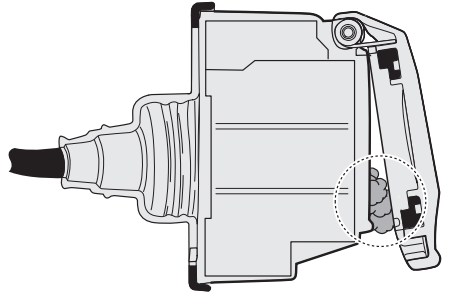
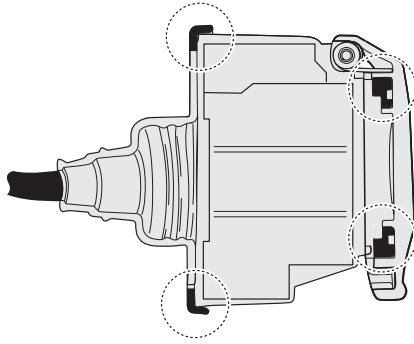
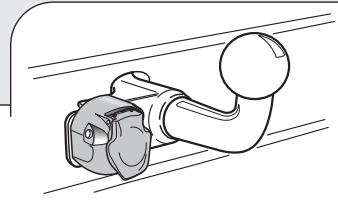
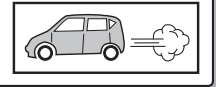

INFO : Ring.

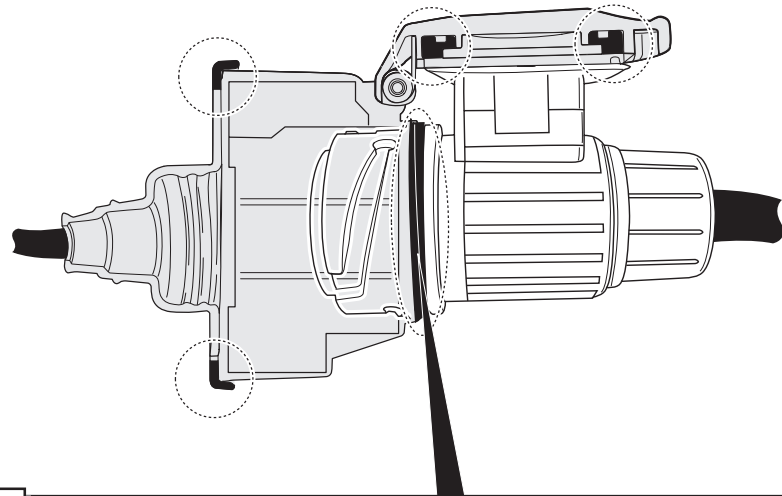
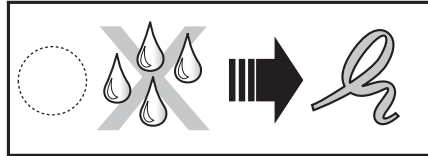
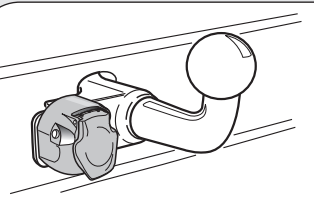
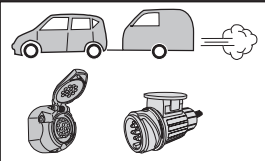

INFO

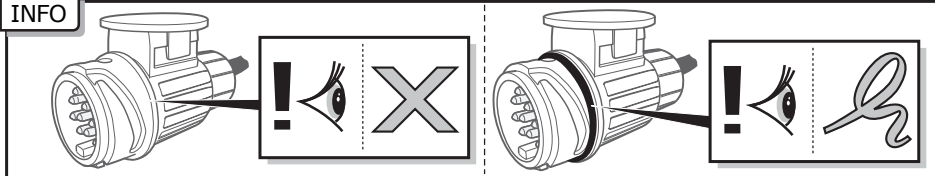

INFO : Adapt.

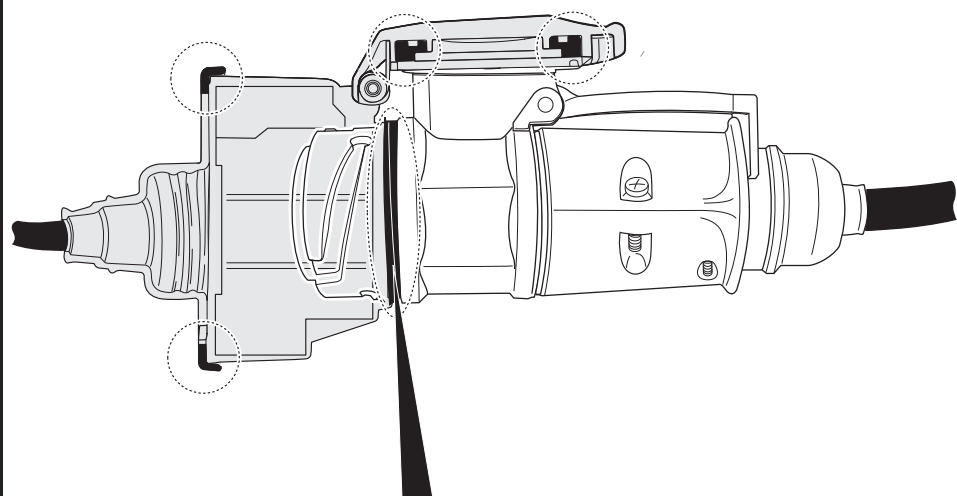
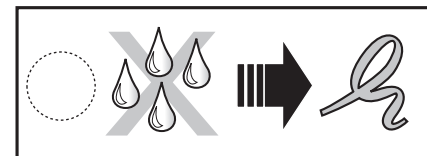
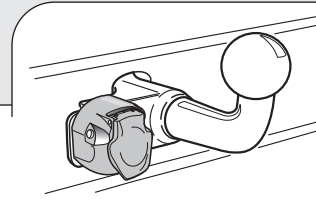
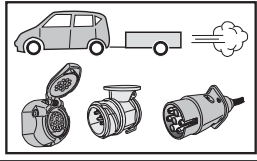

INFO

